



APPROVAL SHEET
FOR
SMD BUZZER

广州粤能科技有限公司

GUANGZHOU YUENENG TECHNOLOGY CO., LTD.

CUSTOMER:

MODEL NO.: YN-YDW10032-40W30

OUR PART NO.:

CUSTOMER PART NO.:

CUSTOMER	APPROVED	CHECKED

Add: ,132 Shishu Road, Yuexiu District, Guangzhou City, Guangdong China.

Mobile:+86-18924165988

skype:18924165988

WhatsApp: +86-18924165988

Email: cngzyn@163.com

1. Technical Parameter

Measuring condition

Part shall be measured under a condition (Temperature: 5 ~ 35°C, Humidity: 45% ~ 85%R.H., Atmospheric pressure: 860 ~ 1060mbar) unless the standard condition (Temperature: 25±2°C, Humidity: 60%~70 %R.H. Atmospheric pressure: 860 ~1060mbar) is regulated to measure.

1	Rated Voltage	3 Vo-p;5 Vo-p;12Vo-p
2	Operating Voltage	1-25Vo-p
3	Rated Current	Max.3mA ; Max.5mA; Max.5mA
4	Sound Output at 10cm	Min.70dB; Min.75dB; Min.75dB
5	Capacitance at 120hz	60000±20%pF
6	Resonant Frequency	4000Hz
7	Operating Temperature	-20°C~+70°C
8	Store Temperature	-30°C~+80°C
9	Net Weight	Approx 0.3g
10	size	10*H2.5mm

2. Dimensions

Unit: mm

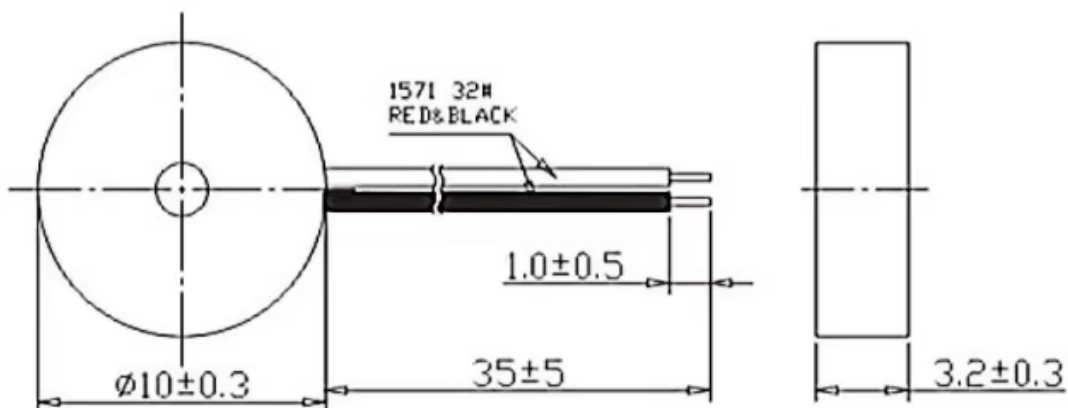

*Unit: mm; Tolerance: ± 0.3 mm Except Specified

*Housing Material: Black LCP

*Terminal plate: 2 soldering pads, tin Plating Brass

3. Electrical And Acoustical Measuring Condition

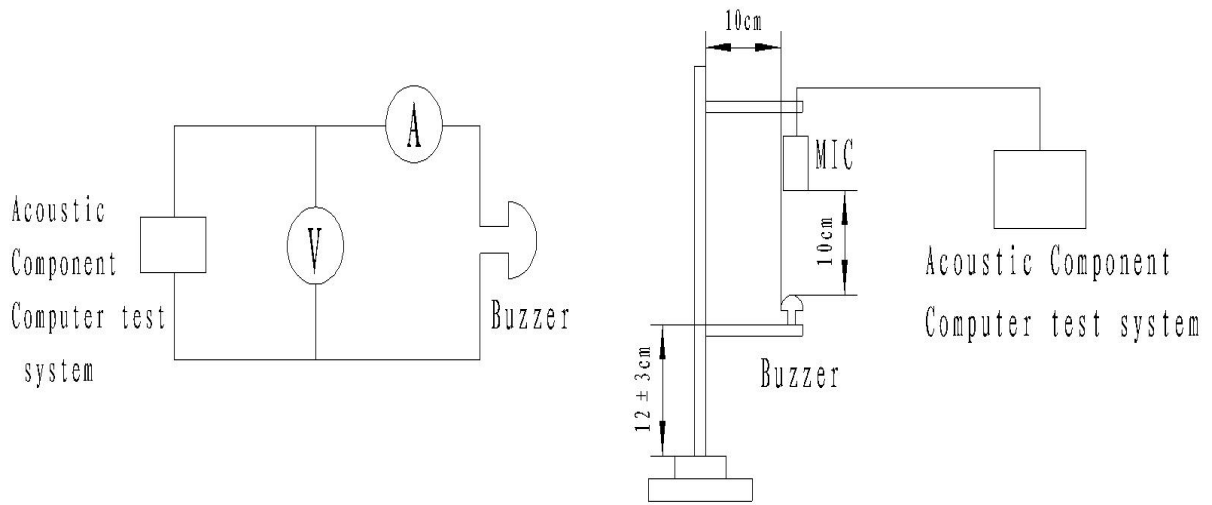

3. Frequency Response

